



PMED

操作手冊
User's Manual
取り扱い説明書

PMED-H1-1-Series

User's Manual

CONTENTS

1. Functions.....	26
2. Specifications.....	26
3. Panel Description.....	27
4. Normal Mode Description.....	27
5. Function Mode Description.....	28
6. Auto-Center (1/2) Function.....	29
7. Count Direction Setting (DIR).....	30
8. Input Signal Setting (ADC).....	31
9. Decimal Point Setting (DOT).....	32
10. Resolution Setting (DPI).....	34
11. Pre-Call (PCALL).....	35
12. Preset Setting (PSET).....	37
13. Relay Enable/Disable Setting (IO.USE).....	39
14. Relay Output Position Setting (IO.SET).....	41
15. Software Version.....	43
16. Description of Input Signal.....	43
17. Description of RS-232 Signal.....	44
18. Description of Output Signal.....	44
19. Dimensions.....	45
20. Parameter Defaults.....	45
21. Appendix.....	46

1. Functions:

- (1) Switch between ABS and REL: See appendix
- (2) Units of measurement: mm/inch
- (3) Zero and auto-center (1/2) function
- (4) Set count direction (increase/decrease)
- (5) Switch between digital and analog signals
 - * Analog signal is only used for the HIWIN Positioning Measurement System
- (6) Decimal point setting
 - mm: 0.001, 0.01, 0.1, 1
 - inch: 0.000001, 0.00001, 0.0001, 0.001
- (7) Resolution setting (unit: μm): 1, 2, 5, 10
- (8) Preset function: 8 sets
- (9) Relay output function: 4 sets
- (10) Current value read (displayed) will be automatically saved during a temporary power failure

2. Specifications:

- ⊙ Display: LED 8 digit display
- ⊙ Input power: 5VDC \pm 5%/1A
- ⊙ Input signal: SIN/COS 1Vp-p(analog), 5V RS-422/TTL(digital)
- ⊙ Relay contact rating: 24VDC/2A
- ⊙ Relay frequency: 2 seconds
- ⊙ Operating temperature range: 0°C ~ +50°C
- ⊙ Storage temperature range: -5°C ~ +65°C

3. Panel Description:

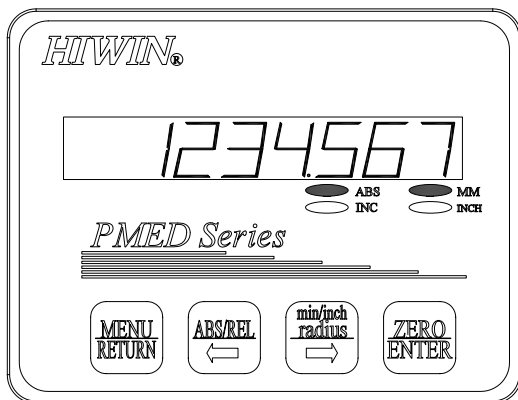

ABS: ABS Mode

INC: REL Mode

MM: Unit: mm

INCH: Unit: inch

4. Normal Mode Description:

Button representation:



: Menu



: Switch between ABS/REL mode



: Switch between units (mm/inch)



: Set zero mark

5. Function Mode Description:

When the display is set on normal mode, press the MENU button to enter into the function mode

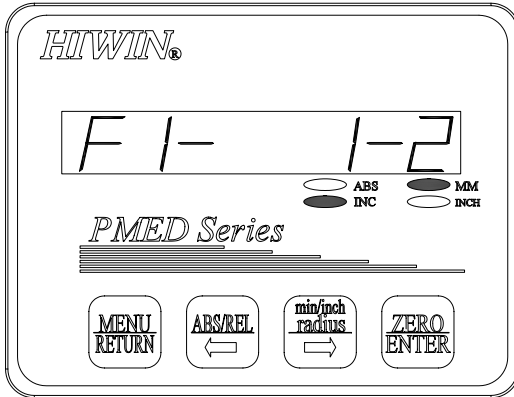

Button representation:



: Return back to normal mode/back one page



: Switch between functions
 F1-1-2>F2-DIR>F3-ADC>F4-DOT>F5-DPI>F6-PCALL>
 F7-PSET>F8-IO.USE>F9-IO.SET> F1-1-2



: Switch between units (mm/inch)
 F1-1-2> F9-IO.SET> F8-IO.USE> >F7-PSET >F6-PCALL>F5-DPI
 >F4-DOT>F3-ADC>F2-DIR> F1-1-2



: Confirmation button

6. Auto-Center (1/2) Function:

Function: To set the auto-center (1/2) value when needed

Caution: Can only be used when the display unit is set on INC mode

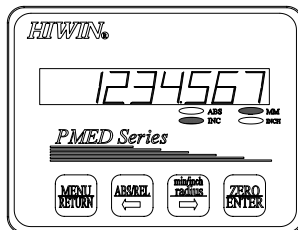

Step 1. If not in INC mode, press



to switch into INC mode

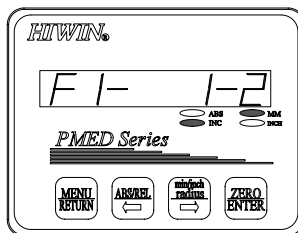

Step 2. Press



once, and then press



or



until it displays F1-1-2 Press



to find the midpoint

7. Count Direction Setting (DIR):

Function: To set the direction (increase or decrease)

Note: Can be used with the display unit set on ABS mode or INC mode

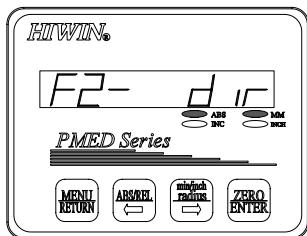

Step 1. Press **MENU RETURN** once, and then press **ABS/REL** or **mm/inch radius**

until it displays F2-DIR

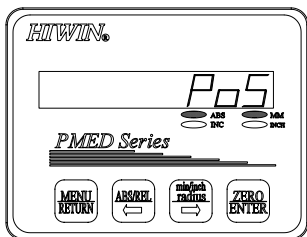

Step 2. Press **ZERO ENTER** to enter setting, then press **ABS/REL** or **mm/inch radius**

to choose the counting direction (positive or negative) Press



to confirm

8. Input Signal Setting (ADC):

Function: Choose the input signal (analog or digital)

Note: Can be used with the display unit set on ABS mode or INC mode

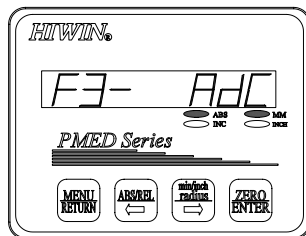

Step 1. Press **MENU/RETURN** once, then press **ABS/REL** or **mm/inch radius** until it displays F3-ADC

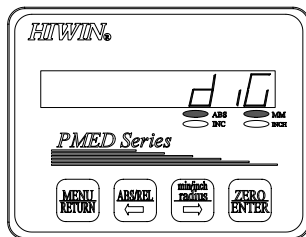

Step 2. Press **ZERO/ENTER** to enter setting, then press **ABS/REL** or **mm/inch radius** to choose DIG (digital signal) or ANA (analog signal) Press **ZERO/ENTER** to confirm

9. Decimal Point Setting (DOT):

Function: To set the decimal point according to the user's requirement

1. For mm, choices are 0.001, 0.01, 0.1, 1

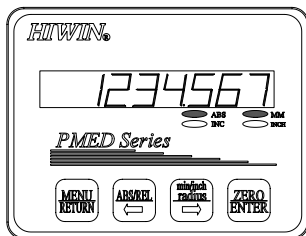

2. For inch, choices are 0.000001, 0.00001, 0.0001, 0.001

Note: Can be used with the display unit set on ABS mode or INC mode



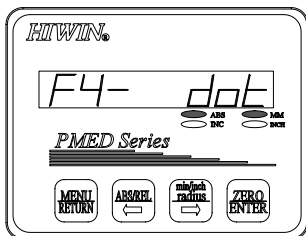



Step 1. Press  to choose the desired unit

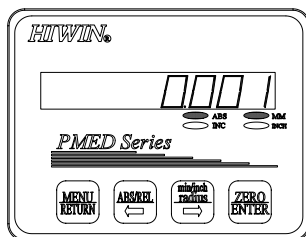

Step 2. Press  once, and then press  or  until it

displays F4-DOT



Step 3. Press  to enter setting, then press  or 

to choose the placement of the decimal point Press  to confirm



10. Resolution Setting (DPI):

Function: To set the resolution according to user's requirement

Choices are 1 μ m, 2 μ m, 5 μ m, 10 μ m

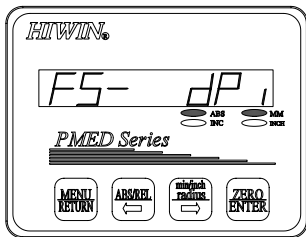

Note: Can be used with the display unit set on ABS mode or INC mode

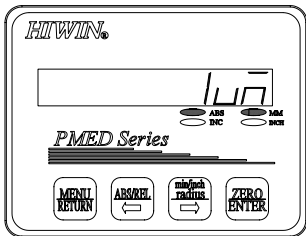

Step 1. Press  once, and then press  or 

until it displays F5-DPI



Step 2. Press  to enter setting, then press  or 

to choose the desired resolution Press  to confirm

11. Pre-Call (PCALL):

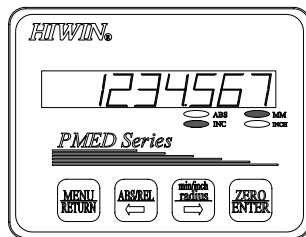

Function: This function can recall the preset parameter

Caution: Can only be used when the display unit is set on INC mode



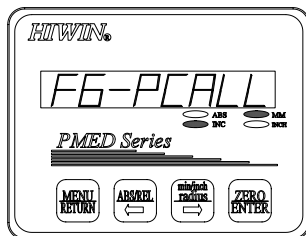

Step 1. If not in INC mode, press  to switch into INC mode

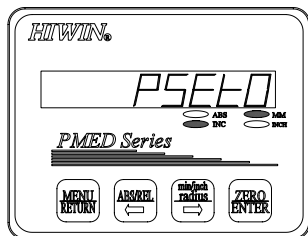

Step 2. Press  once, and then press  or  until it displays F6-PCALL



Step 3. Press  to enter setting, and then press 

or  to choose which set of number presets you require Press

 to confirm

12. Preset Setting (PSET):

Function: Preset number setup

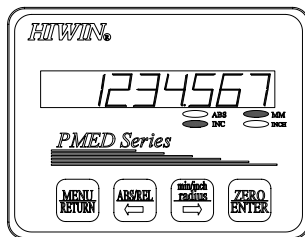

The preset function offers 8 sets

Caution: Can only be used when the display unit is set on INC mode



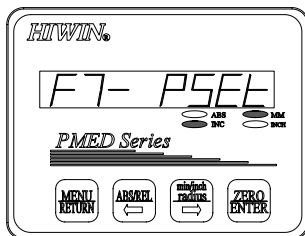

Step 1. If not in INC mode, press  to switch into INC mode



Step 2. Press  once, and then press  or  until it

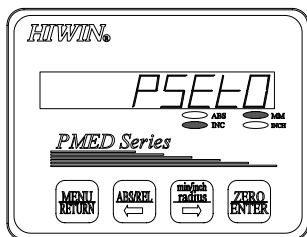

displays F7-PSET



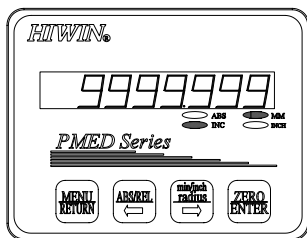

Step 3. Press  to enter setting, and then press 

or  to choose which set of number presets you require



Step 4. Press  to enter setting, and then press  to change

the blinking digit Press  to change the value, and

press  to change to the next digit Press  to confirm

13. Relay Enable/Disable Setting (IO.USE):

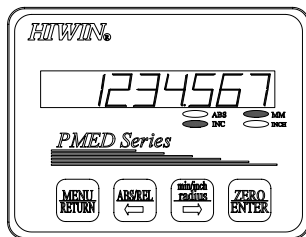

Function: Relay enable/disable setting

Caution: Can only be used when the display unit is set on INC mode



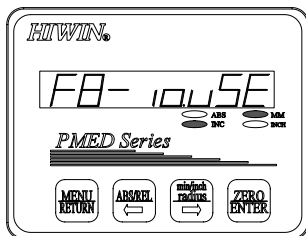

Step 1. If not in INC mode, press  to switch into INC mode



Step 2. Press  once, and then press  or  until it

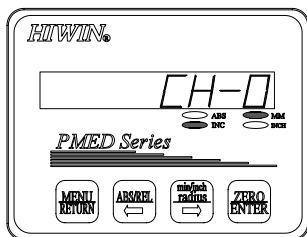

displays F8-IO.USE

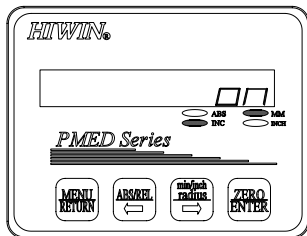

Step 3. Press  to enter setting, and then press 

or  to choose which set of number presets you require



Step 4. Press  to enter setting, and then press 

or  to setup the relay enable or disable function

14. Relay Output Position Setting (IO.SET):

Function: Relay output position setup

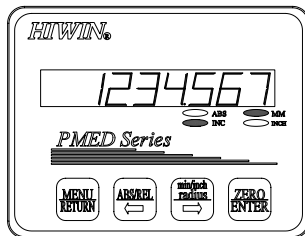

Relay output: 4 sets

Caution: Can only be used when the display unit is set on INC mode



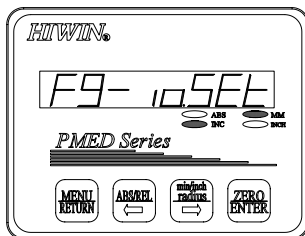



Step 1. If not in INC mode, press  to switch into INC mode



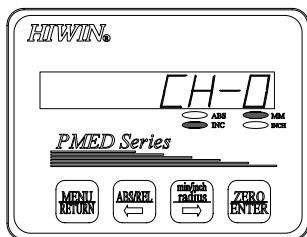

Step 2. Press  once, and then press  or  until it

displays F9-IO.SET

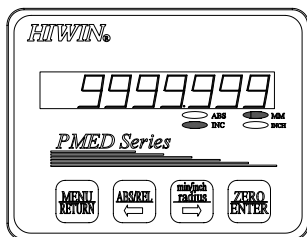

Step 3. Press  to enter setting, then press  or  to choose the position setting (CH-0~CH-3)



Step 4. Press  to enter setting, press  to change the

blinking number, and then press  to change the value

Press  to change to the next number. When completely finished

setting the numbers, press  to confirm

15. Software Version:

Function: The systems software version

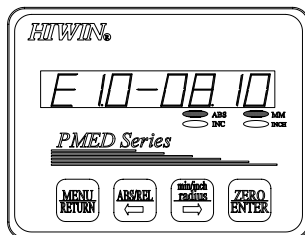

When powered on, the panel will display the current software version for about 3 seconds

16. Description of Input Signal:

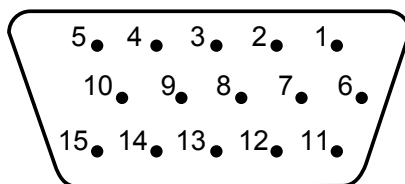

D-sub VGA 15 Pin Female

Pin	Signal	Pin	Signal	Pin	Signal
1	+5V	6	FG	11	A+(Analog)
2	GND	7	Z+	12	A-(Analog)
3	A+(Digital)	8	Z-	13	B+(Analog)
4	B+(Digital)	9	A-(Digital)	14	B-(Analog)
5	NC	10	B-(Digital)	15	NC

17. Description of RS-232 Signal:

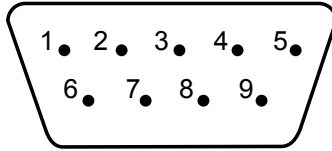

D-sub 9 Pin male

Pin	Signal	Pin	Signal
1	NC	6	NC
2	TXD	7	NC
3	RXD	8	NC
4	NC	9	NC
5	GND		

18. Description of Output Signal:

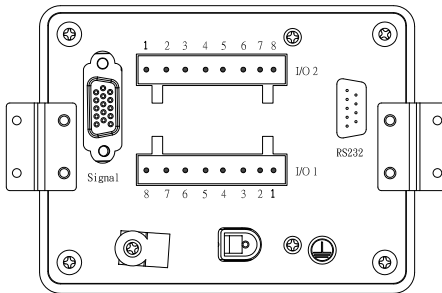

I/O 1		I/O 2	
Pin	Designation	Pin	Designation
1	NC	1	NC
2		2	NC
3	NC	3	NC
4		4	NC
5	Relay 0(CH-0)	5	Relay 2(CH-2)
6		6	
7	Relay 1(CH-1)	7	Relay 3(CH-3)
8		8	

19. Dimensions:

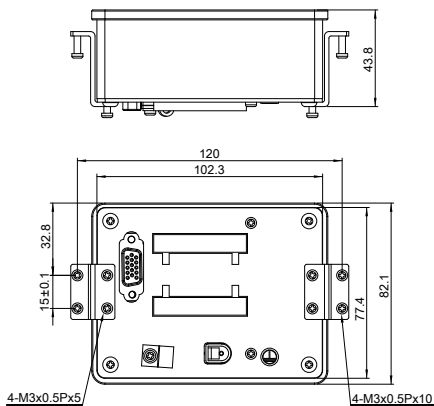

20. Parameter Defaults:

Function	Description	Default
F2-DIR	Counting Direction	POS(positive)
F3-ADC	Input Signal	ANA(analog signal)
F4-DOT	Decimal Point	mm: 0.001 inch: 0.000001
F5-DPI	Resolution	1μm
F6-PCALL	Pre-Call	PSET 0
F7-PSET	Preset	PSET 0~PSET 7=0
F8-IO.USE	Relay Enable/Disable	CH-0~CH-3: OFF
F9-IO.SET	Relay Output	CH-0~CH-3=0

21. Appendix:

Panel display (number and letter (function) representation):

Name	LED Display	Name	LED Display	Name	LED Display
0	0	1	1	2	2
Name	LED Display	Name	LED Display	Name	LED Display
3	3	4	4	5	5
Name	LED Display	Name	LED Display	Name	LED Display
6	6	7	7	8	8
Name	LED Display	Name	LED Display	Name	LED Display
9	9	A	A	B	b
Name	LED Display	Name	LED Display	Name	LED Display
C	C	D	d	E	E
Name	LED Display	Name	LED Display	Name	LED Display
F	F	G	G	H	H
Name	LED Display	Name	LED Display	Name	LED Display
I	I	J	J	K	K
Name	LED Display	Name	LED Display	Name	LED Display
L	L	M	M	N	N
Name	LED Display	Name	LED Display	Name	LED Display
O	O	P	P	Q	Q
Name	LED Display	Name	LED Display	Name	LED Display
R	R	S	S	T	T
Name	LED Display	Name	LED Display	Name	LED Display
U	U	V	V	W	W
Name	LED Display	Name	LED Display	Name	LED Display
X	X	Y	Y	Z	Z

(2). Technical description:

(a). Absolute mode:

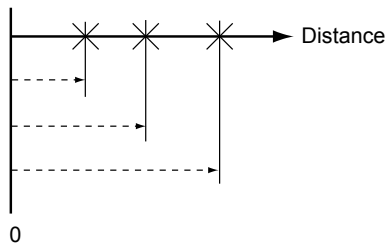

Has the same origin, the position of the origin can not be changed

(b). Relative mode:

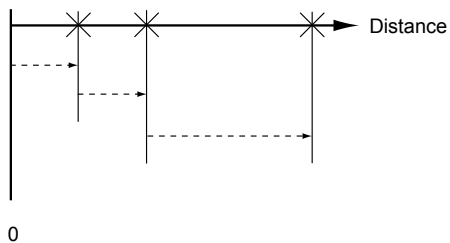

The position of the origin can be changed based on your demand

HIWIN®

Motion Control and System Technology

Hiwin Mikrosystem Corp.

No.7, Jingke Rd., Nantun District,

Taichung City 40852, Taiwan

Tel: +886-4-2359-3314

Fax: +886-4-2355-0123

www.hiwinmikro.com.tw

business@mail.hiwinmikro.com.tw



©2010 FORM E02U01-1009